

SANITARY SERIES

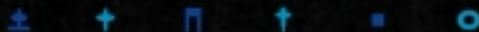
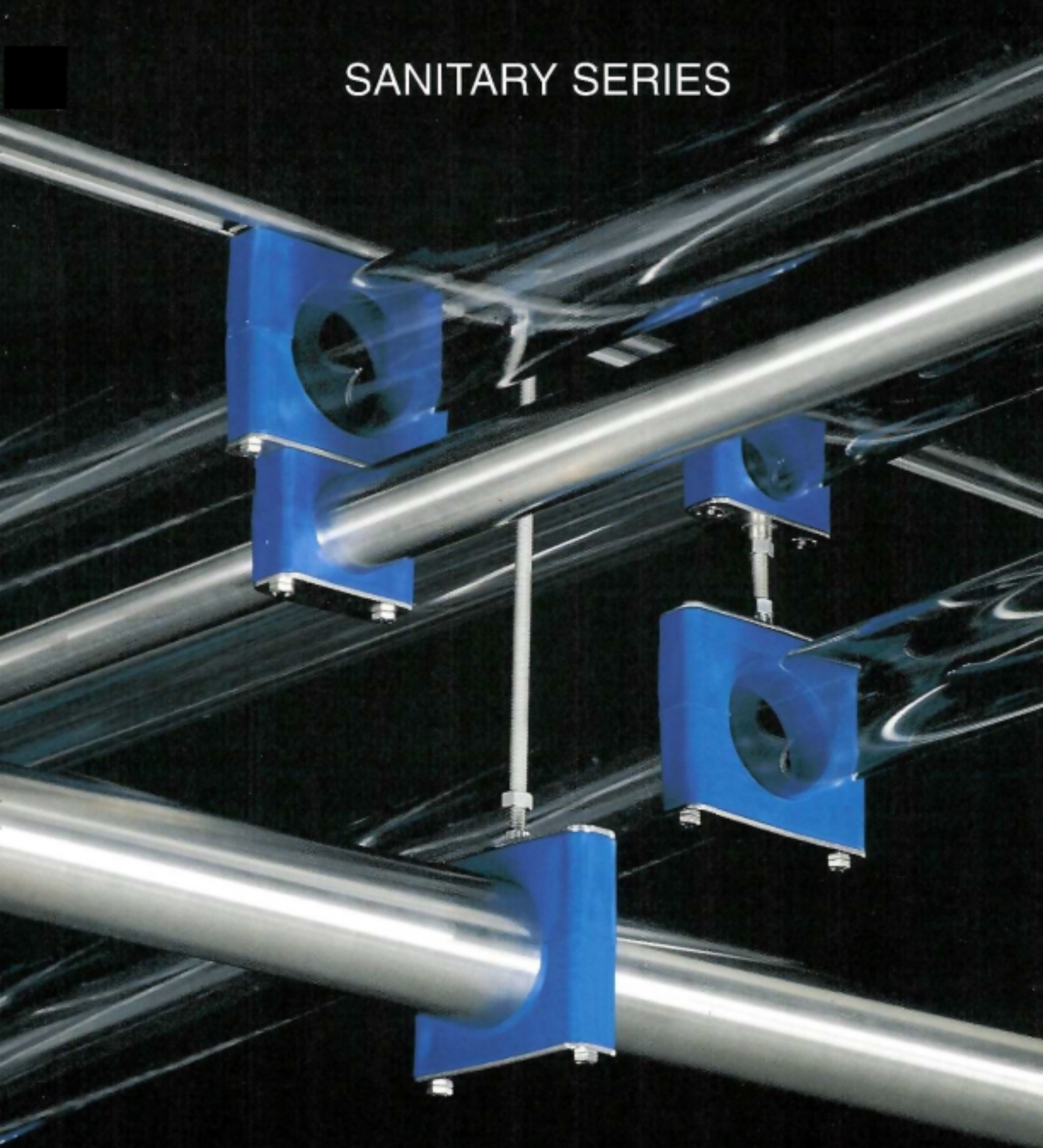

LIMECREST ROAD
P.O. BOX 626, LONG POND ESTATES
ANDOVER, NJ 07821
PHONE (973) 579-2959 • FAX (973) 579-7275

BEHRINGER PIPE AND TUBE SUPPORTS

EASY TO USE- MAINTENANCE FREE

Engineering, plant, and maintenance personnel appreciate the Behringer Clamp's rugged construction, simplicity and clean design. Behringer clamp components can be quickly and effectively secured and are virtually maintenance free. Our modular clamp design assures greater flexibility in assembly, adjustment and stacking, as well as an endless variety of application configurations to suit every need.

Standard hardware is 304 grade stainless steel. Type 316 grade stainless is available as well as electro-zinc plated carbon steel upon request.

Our injection-molded clamp halves have outstanding physical properties. They offer excellent dielectrical and accoustical insulating properties. Molded from Santoprene (an FDA regulated thermo-plastic rubber) or Polypropylene, our clamp halves offer a wide range of thermal properties, (-22°F to 212°F for PP; -40°F to 302°F for SP). Santoprene has excellent resistance to a broad range of food such as milk, beer, wine, vinegar and beverage syrups. Behringer Santoprene clamp halves also offer resistance to salt water, oils as well as most acids, alkalis and other chemical solutions.

All clamp halves in our Sanitary Series incorporate a "smooth bore" contact surface between clamp and tube diameter. This concept was developed to prevent bacteria from harboring in any recesses. Behringer's Standard, Twin and Heavy Series Pipe Supports offer ribbed contact surfaces for greater clamping pressures, Standard, Twin and Heavy Series Clamp Halves are also offered with stainless steel hardware, aluminum inserts for high temperature applications and accomodate pipe and tube diameters ranging from 1/4" O.D. thru 30" O.D.

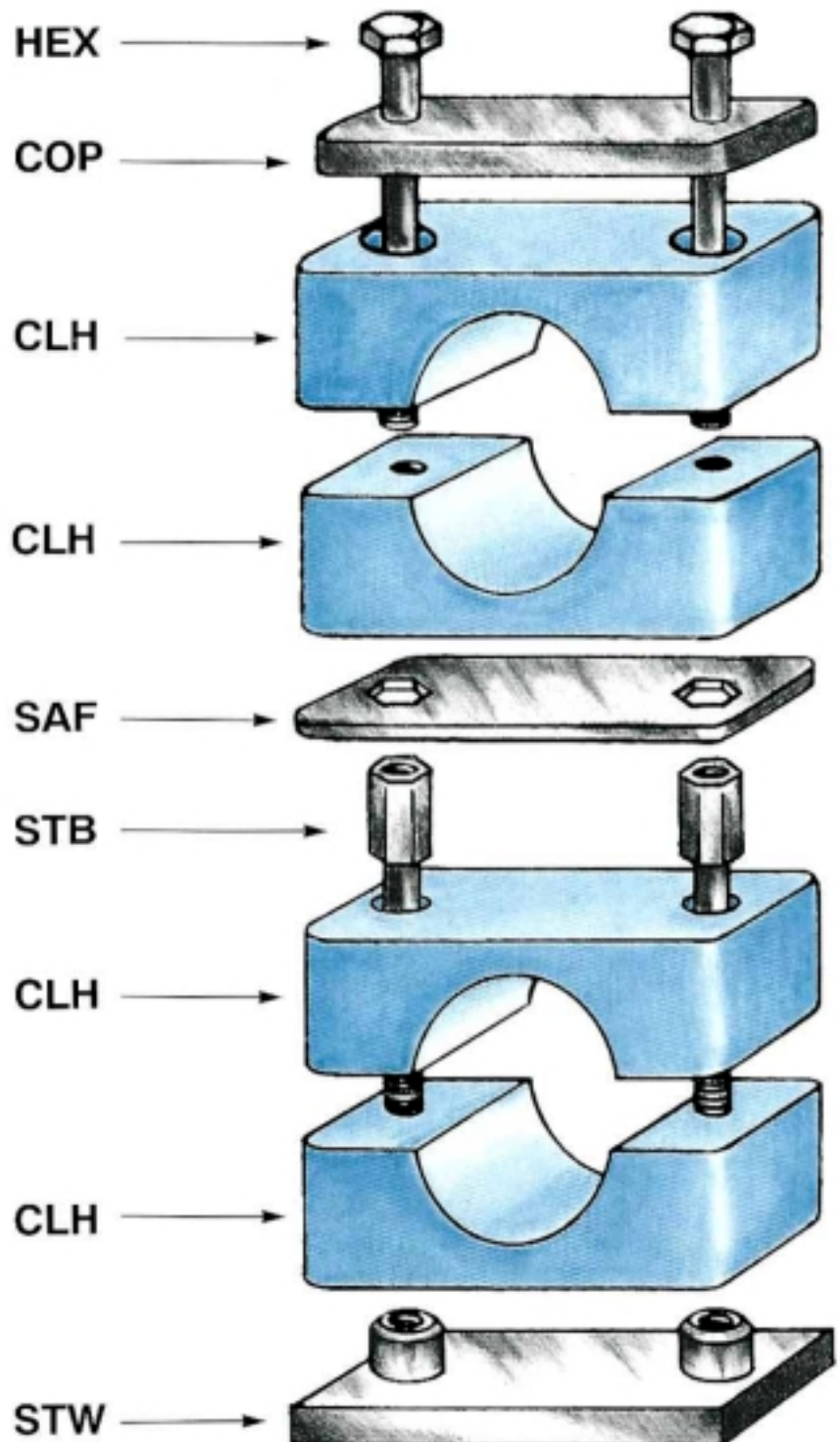



FIG 1: Transfer Plate allows vertical stacking of Behringer clamps to be easily accomplished for clamps of the same or different group sizes. Stacking bolts are used for clamps of the same group while a transfer plate connects clamps of different groups.

ORDER EXAMPLE: A 2" Tube stacked on a 3" Tube, mounted on Base Plate, Polypropylene Clamp Halves, SS304 Hardware.

NECESSARY COMPONENTS: 1 pc. COP-6-SS; 2 pcs. HEX-6-SS; 1 SET SB6200-PP; 1 pc. TRP-7-6-SS; 2 pcs. HEX-7-SS; 1 SET SB7300-PP; 1 pc. BAP-7-SS.



FIG 3: Ceiling mount is the simplest way to suspend pipe or tube while still allowing maximum flexibility in vertical adjustment and pipe direction.

ORDER EXAMPLE: 2" ceiling mounted hung from Threaded Rod, Polypropylene Clamp Halves, SS316 Hardware.

NECESSARY COMPONENTS: 1 pc. CMP-SS316; 2 pcs. LCN-SS316; THR-SS316; HAP-7-SS316; 1 SET SB72375-PP; 1 pc. COP-7-SS316; 2 pcs. HEX-7-SS316.

FIG 2: Hang Plate allows multiple suspension with an endless array of vertical arrangements. Behringer's modular design allows multiple pipes in **ANY** direction.

ORDER EXAMPLE: 3x3" Tubes, 1x2" Tube Offset; Santoprene Clamp Halves, SS304 Hardware.

NECESSARY COMPONENTS:

1 pc. CMP-6-SS;
4 pcs. LCN-SS;
2 LENGTHS THR-SS;
1 pc. HAP-7-SS;
3 SETS SB7300-SP;
4 pcs. STB-7-SS;
2 pcs. SAF-7-SS;
1 pc. SWV-7-SS;
1 pc. HAP-6-SS;
1 SET SB6200-SP;
1 pc. COP-6-SS;
2 pcs. HEX-6-SS.



Behringer Weld Plates incorporate a U.S. and Foreign Patented technique for attaching the weld nut to the weld plate assuring consistent and uniform torque and pull resistance. U.S. Patent No. 4,251,755.

Behringer's new Sanitary Series Pipe Support System incorporates a U.S. and Foreign Patent

ORDERING COMPONENTS

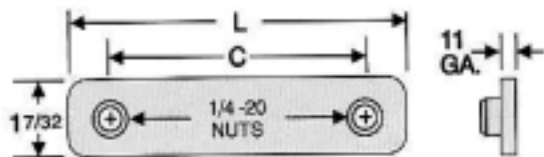

STANDARD WELD PLATE (STW)*

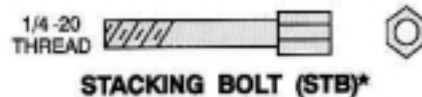

STACKING BOLT (STB)*

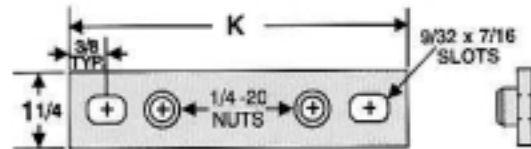

BASE PLATE (BAP)*



LOCK NUT (LCN)

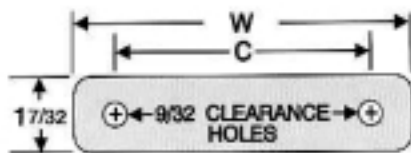

COVER PLATE (COP)*

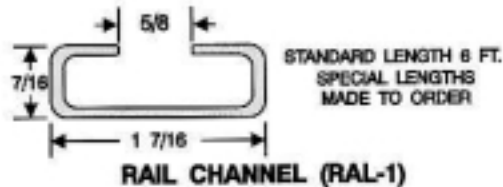

RAIL CHANNEL (RAL-1)

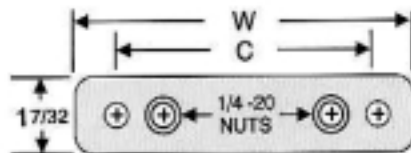

TRANSFER PLATE (TRP)*



RAIL CLAMPING NUT (RCN-1)

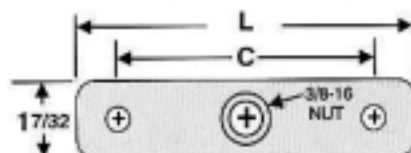

SWIVEL PLATE (SWV)*

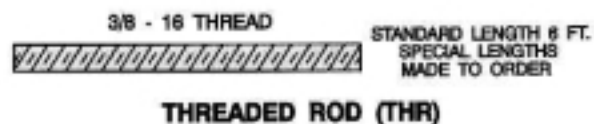

THREADED ROD (THR)

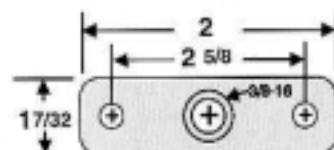

CEILING MOUNTING PLATE (CMP)



HEX BOLT (HEX)*

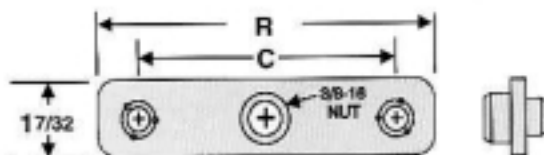

HANG PLATE (HAP)*

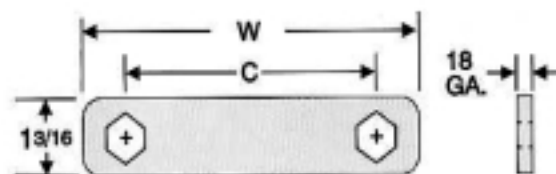

SAFETY PLATE (SAF)*

NOTES

- *SPECIFY GROUP NO.
- GROUP #8 INCORPORATES 3/16" TOP AND BOTTOM PLATE MATERIAL THICKNESS AT 1 1/2" WIDE WITH 3/8-16 MOUNTING BOLTS; 5/8-11 HANG THREAD.
- GROUPS #8 & #9 CANNOT BE STACKED OR RAIL MOUNTED.
- GROUP #9 INCORPORATES 3/8" TOP AND BOTTOM PLATE MATERIAL THICKNESS AT 1 3/4" WIDE WITH 5/8-11 MOUNTING BOLTS.

SANITARY SERIES TUBE/PIPE HANGER ORDERING GUIDE

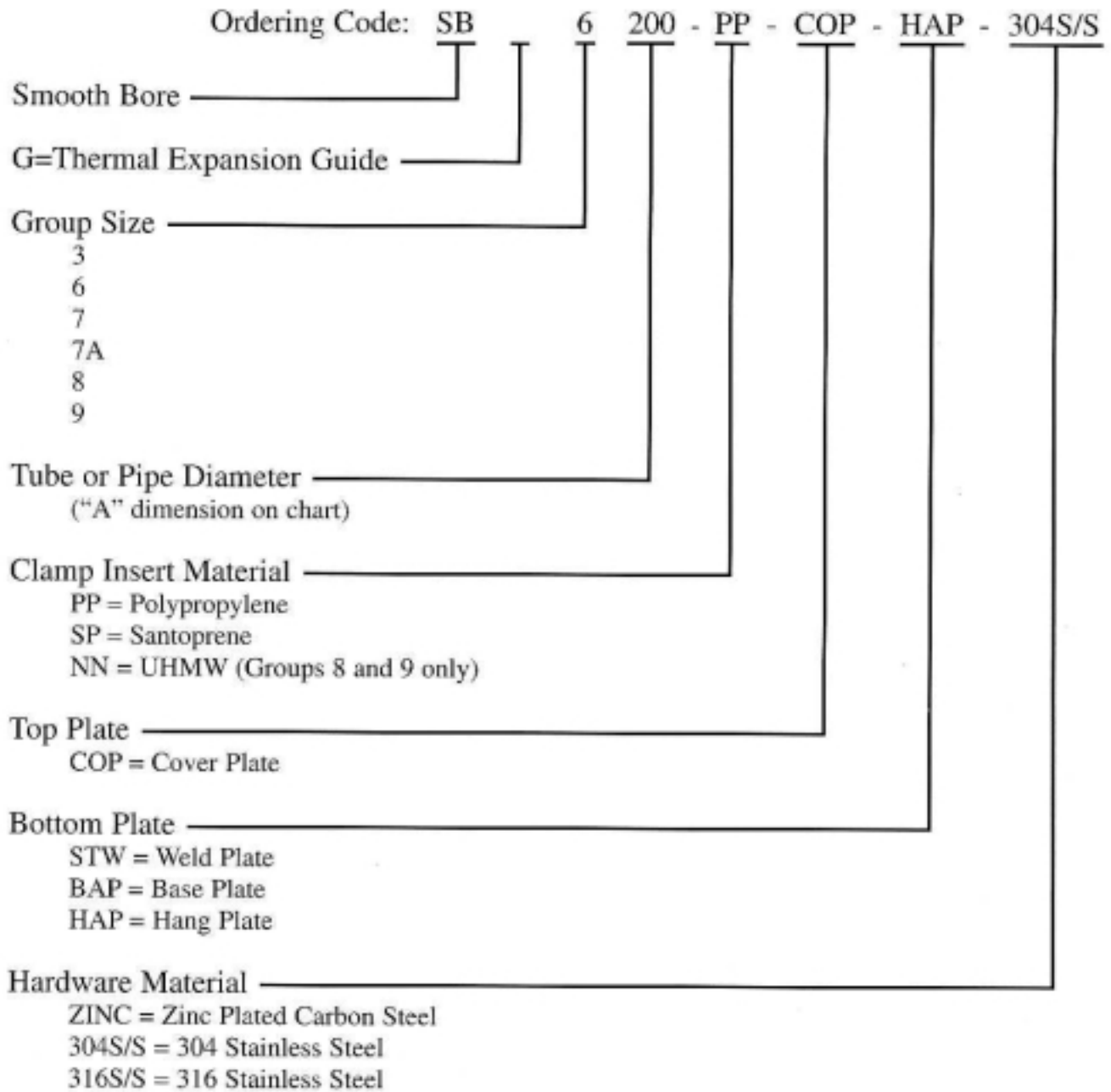

GROUP NO.	NOM SIZE	PLASTIC PART NO.	A	D	W	H	C	L	U	K	Z	R	BOLT SIZE	HANG THREAD
3	1/4 T	SB 3025-**	025	.250	1.88	1.38	1.30	2.06	.81	3.50	1.19	1.98	1/4-20	3/8-16
	3/8 T	SB 30375-**	0375	.375										
	1/2 T	SB 3050-**	050	.500										
	3/4 T	SB3075-**	075	.750										
	1/2 P	SB 30840-**	0840	.840										
	1 T	SB 3100-**	100	1.000										
6	1/4 T	SB 6025-**	025	.250	3.34	2.63	2.60	3.37	1.44	4.88	1.19	3.47	1/4-20	3/8-16
	3/8 T	SB 60375-**	0375	.375										
	1/2 T	SB 6050-**	050	.500										
	5/8 T	SB 60625-**	0625	.625										
	3/4 T	SB 6075-**	075	.750										
	1/2 P	SB 60840-**	0840	.840										
	7/8 T	SB 60875-**	0875	.875										
	1 T	SB 6100-**	100	1.000										
	3/4 P	SB 61050-**	1050	1.050										
	1 1/4 T	SB 6125-**	125	1.250										
	1 P	SB 61315-**	1315	1.315										
	1 1/2 T	SB 6150-**	150	1.500										
	1 1/4 P	SB 61660-**	1660	1.660										
	1 1/2 P	SB 61900-**	1900	1.900										
7	2 T	SB 7200-**	200	2.000	5.00	4.38	4.25	5.03	2.31	6.50	1.19	5.50	1/4-20	3/8-16
	2 P	SB 72375-**	2375	2.375										
	2 1/2 T	SB 7250-**	250	2.500										
	2 1/2 P	SB 72875-**	2875	2.875										
	3 T	SB 7300-**	300	3.000										
	3 1/2 T-3P	SB 7350-**	350	3.500										
7A	4 T	SB 7A400-**	400	4.000	5.77	4.80	4.95	5.77	2.54	-	1.19	5.75	1/4-20	3/8-16
8	6 T	SB 8600-NN	600	6.000	8.88	7.65	7.75	9.50	4.01	-	1.50	9.50	3/8-16	5/8-11
9	8 T	SB 9800-NN	800	8.000	12.50	10	10.44	14.50	5.38	-	1.75	-	5/8-11	-

**INSERT MATERIAL: PP = POLYPROPYLENE; SP = SANTOPRENE; NN = UHMW

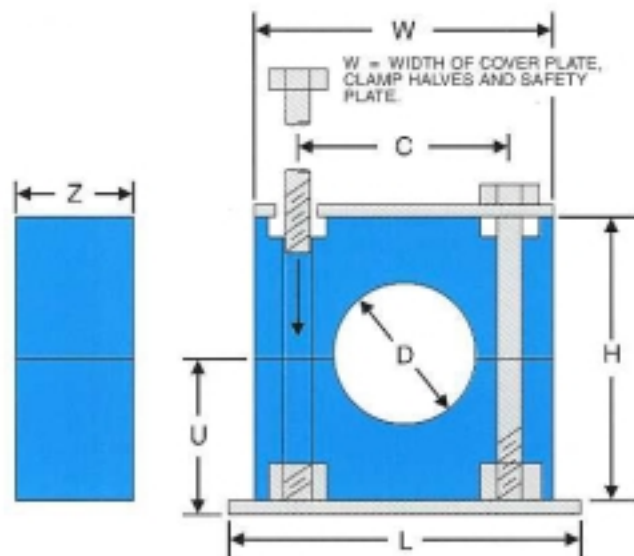

NOTES:

1. WHEN ORDERING STEEL HARDWARE SPECIFY GROUP NO. THEN -SS FOR TYPE 304 STAINLESS; -SS316 FOR TYPE 316 STAINLESS OR ONLY GROUP NO. FOR PLATED HARDWARE (SEE ORDERING EX.)
2. RAL-1 AND THR (THREADED ROD) COME IN 6 FT. LENGTHS.
3. SANITARY CLAMPS CAN ALSO BE ADAPTED TO UNI-STRUT CHANNEL.
4. CONTACT FACTORY FOR ADDITIONAL INFORMATION.
5. CUSTOM DIAMETERS AVAILABLE UPON REQUEST.



± † ∏ † ■ ○
 RUBBER FAB MOLD & GASKET • LIMECREST ROAD
 P.O. BOX 628, LONG POND ESTATES • ANDOVER, NJ 07821
 PHONE (973) 579-2959 • FAX (973) 579-7275

COPYRIGHT © 2000 BEHRINGER, INC.

NO. SB06005



Behringer clamps are approved for class 100 clean room installations. High purity installations.

